

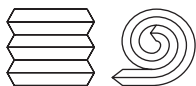

PERFECTA

PLISSÈ - RULLO



LINEA INDOOR



COLORE ALLUMINIO

RAL standard

	SEMILUCIDO BIANCO 9010
	SEMILUCIDO AVORIO 1013
	SEMILUCIDO MARRONE 8017
	TESTA DI MORO SCURO
	ARGENTO OX

LEGNO +10%

	BIANCO FRASSINO
	AVORIO FRASSINO
	GOLDEN OAK
	TERRA

È una tenda tecnica da interno frizionata con meccanica a rullo o plissettata.

L'ampia possibilità di teli oscuranti e filtranti permette l'applicazione in diversi ambienti, abbinandoli al colore dell'infisso.

L'installazione facile e immediata si effettua con il fissaggio delle apposite clips posizionate tra il vetro e il profilo fermavetro, se profondo tra 16 e 32 mm.

In presenza di fermavetro con profondità superiore a 32 mm è previsto il fissaggio con viti.

ATTENZIONE: I teli oscuranti non garantiscono un oscuramento totale del 100%.

COLORE ACCESSORI



COME ORDINARE



Le dimensioni di Perfecta devono essere trasmesse in millimetri indicando larghezza x altezza e la profondità del fermavetro (minimo 16 mm).

Perfecta sormonta il fermavetro di 25 mm, pertanto verificare che la posizione della maniglia dell'infisso non interferisca con l'ingombro del prodotto.

PRODOTTI SPECIALI

Richiedere preventivo in azienda

OSCURANTE - FILTRANTE DOUBLE

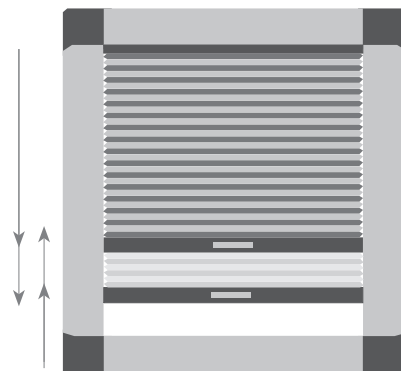

REVERSIBILE

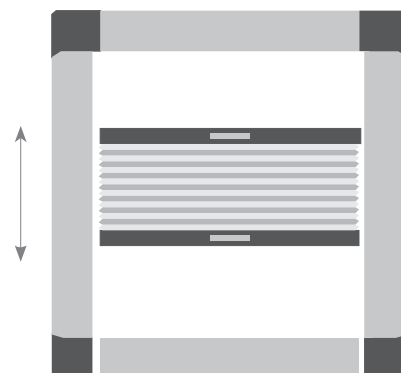

A RICHIESTA

RAL
RENOLIT PELLICOLE
SKAI PELLICOLE

Per un perfetto abbinamento il colore dei due elementi deve essere identico. La varietà delle finiture in uso nel mercato impone la soluzione personalizzata del colore; pertanto l'azienda è in grado di offrire la gestione di queste colorazioni personalizzate previo accordo commerciale.





PERFECTA

PLISSÈ

LINEA INDOOR

! LIMITI DIMENSIONALI (cm)

	L	H
MIN.	40	40
MAX.	180	220

INSTALLAZIONE

Facile e immediata, per altezza fermavetro fino a 32 mm si effettua tramite il fissaggio delle apposite clips posizionate tra il vetro e il profilo fermavetro. Per profondità maggiore l'installazione deve essere effettuata tramite apposite viti di fissaggio.

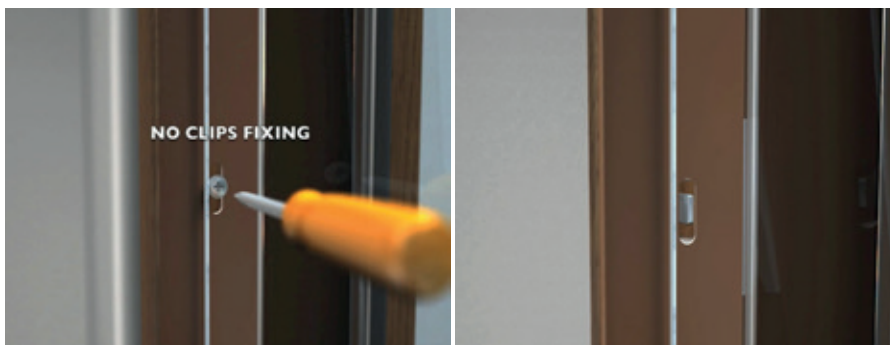
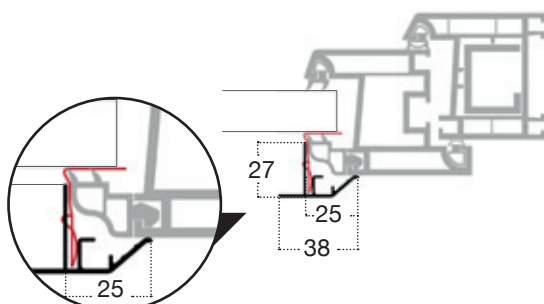

OPTIONAL

ASTA DI AZIONAMENTO H 200 cm



LISTINO B IVA ESCLUSA

PERFECTA - PLISSÈ																																							
Largh.	40	50	60	70	80	90	100	110	120	130	140	150	160	170	180																								
Altezza (cm)	40	79	84	88	94	96	104	105	115	115	127	124	137	132	146	140	156	148	166	157	175	165	185	176	200	187	213	193	218	198	224								
	50	84	93	94	103	103	113	113	127	125	139	134	150	143	161	151	172	161	182	170	193	179	204	192	220	204	237	210	242	215	247								
	60	91	100	101	111	110	124	123	137	134	151	144	163	153	175	163	187	173	199	183	211	193	222	207	242	221	261	227	266	232	271								
	70	97	107	107	121	118	133	131	148	143	163	153	176	164	190	175	203	185	215	196	229	207	242	245	239	284	249	267	289	249	295								
	80	102	114	114	129	126	143	139	160	152	175	164	190	175	204	186	218	198	232	209	246	220	261	238	284	255	307	261	312	266	317								
	90	109	122	122	137	134	153	147	170	162	187	175	203	187	218	199	234	210	249	222	265	235	279	253	305	273	331	278	336	283	341								
	100	115	130	128	146	141	163	156	181	171	200	183	216	197	233	209	249	222	266	236	282	248	299	269	327	289	354	295	359	300	365								
	110	122	137	135	155	148	172	165	193	180	212	194	230	208	247	221	265	235	282	248	300	263	317	284	348	307	378	312	383	317	388								
	120	128	144	142	164	157	182	173	203	190	224	204	243	218	262	233	280	247	299	262	317	276	337	300	369	324	402	330	407	334	412								
	130	134	152	148	172	164	192	181	214	199	236	213	255	229	276	244	296	260	315	275	336	290	355	315	390	341	425	346	431	351	436								
	140	139	160	156	180	172	202	190	225	208	248	224	269	240	290	255	311	272	333	288	353	304	375	331	412	357	449	363	454	368	459								
	150	145	167	163	190	179	211	198	236	217	260	234	282	250	305	268	327	284	349	301	371	318	393	346	433	375	472	380	477	385	482								
	160	151	174	169	198	186	221	206	246	227	272	244	296	262	319	279	342	297	366	314	389	332	413	362	454	-	-	-	-	-	-								
	170	158	182	176	206	195	231	215	258	236	284	253	309	272	334	290	357	309	382	328	407	346	432	377	475	-	-	-	-	-	-								
180	164	190	183	215	202	241	224	269	245	297	264	322	283	348	302	373	321	399	341	424	359	450	392	496	-	-	-	-	-	-									
190	170	197	190	224	209	250	232	279	254	309	274	336	294	362	314	389	334	416	353	443	374	469	408	517	-	-	-	-	-	-									
200	176	204	197	232	217	260	240	290	264	320	284	348	305	376	325	405	346	433	367	460	387	488	423	539	-	-	-	-	-	-									
210	181	212	203	241	225	270	248	302	273	333	295	362	315	390	337	420	358	449	380	478	-	-	-	-	-	-	-	-	-	-									
220	187	219	210	249	232	280	258	312	282	345	304	375	327	405	348	436	371	466	393	496	-	-	-	-	-	-	-	-	-	-									
Cat.	L	M	L	M	L	M	L	M	L	M	L	M	L	M	L	M	L	M	L	M	L	M	L	M	L	M	L	M	L	M									

Prezzi validi per i colori RAL standard, +10% per i colori LEGNO.

PERFECTA

RULLO



! LIMITI DIMENSIONALI (cm)

	L	H
MIN.	40	70
MAX.	130	200

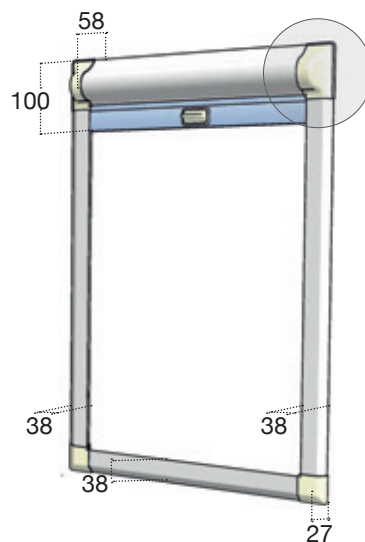

REGISTRAZIONE MOLLA

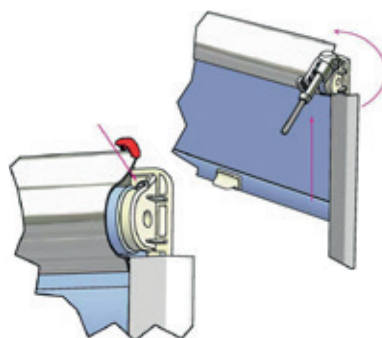

LISTINO B IVA ESCLUSA

PERFECTA - RULLO		40			50			60			70			80			90			100			110			120			130			
Largh.	Altezza (cm)	40	71	73	84	77	79	96	83	88	106	92	94	116	100	103	130	107	111	139	113	118	142	121	126	160	127	133	171	130	136	176
	40	71	73	84	77	79	96	83	88	106	92	94	116	100	103	130	107	111	139	113	118	142	121	126	160	127	133	171	130	136	176	
	50	74	77	93	82	84	103	89	93	115	96	100	127	105	110	140	111	117	151	119	126	163	126	133	175	134	139	185	137	144	192	
	60	79	81	100	85	90	111	93	98	125	101	105	137	111	116	151	117	124	164	126	131	176	132	139	188	139	148	202	143	151	208	
	70	83	85	107	91	94	121	98	102	134	106	111	147	115	121	163	123	130	176	130	139	191	139	147	204	146	156	216	149	159	222	
	80	87	91	113	95	99	129	102	108	143	111	116	158	121	128	174	129	136	188	136	145	204	144	153	218	152	163	232	157	167	240	
	90	92	95	121	99	104	136	107	112	151	115	122	167	126	134	185	134	143	201	142	151	216	149	161	232	158	170	247	163	175	255	
	100	95	100	128	103	109	144	111	118	161	121	128	177	130	139	196	139	148	213	148	158	230	157	167	246	165	177	263	168	182	271	
	110	99	103	135	107	113	151	116	124	170	126	134	187	136	145	208	144	156	226	153	166	243	163	176	260	171	185	278	176	191	287	
	120	102	108	142	111	118	161	121	129	179	130	139	198	141	151	218	149	162	238	159	172	256	168	182	275	176	193	294	181	198	303	
	130	107	112	148	116	124	168	126	134	188	135	144	209	146	158	231	156	167	250	165	178	269	174	190	289	183	200	309	187	204	319	
	140	111	117	157	121	129	176	130	139	198	139	149	218	151	163	241	161	175	262	171	185	283	180	196	304	190	207	324	195	213	334	
	150	114	121	163	125	133	185	135	144	207	144	155	229	157	169	252	166	180	274	176	192	297	185	203	318	195	214	340	201	219	350	
	160	118	126	170	129	137	193	139	148	216	148	161	238	161	175	264	172	186	286	182	198	309	192	210	332	202	222	355	207	228	367	
	170	124	130	177	133	142	201	143	155	225	155	167	248	167	180	271	177	193	299	187	205	322	198	216	346	208	229	371	213	235	382	
	180	127	135	184	139	147	209	148	160	234	159	172	260	172	186	286	182	199	311	193	211	336	204	225	362	214	237	386	219	243	399	
	190	-	-	-	142	151	217	152	165	243	164	177	269	176	193	297	188	206	323	199	218	349	210	232	375	220	244	402	226	250	414	
	200	-	-	-	-	-	-	158	170	252	169	182	279	182	199	309	194	212	336	204	226	363	215	238	389	227	251	417	232	259	430	
Cat.		A	B	C	A	B	C	A	B	C	A	B	C	A	B	C	A	B	C	A	B	C	A	B	C	A	B	C	A	B	C	

Prezzi validi per i colori **RAL** standard, +10% per i colori **LEGNO**.



LINEA INDOOR



PERFECTA

PLISSÈ

FILTRANTI

Listino Tariffa **L**

OSCURANTI

Listino Tariffa **M**

FIRE RETARDANT

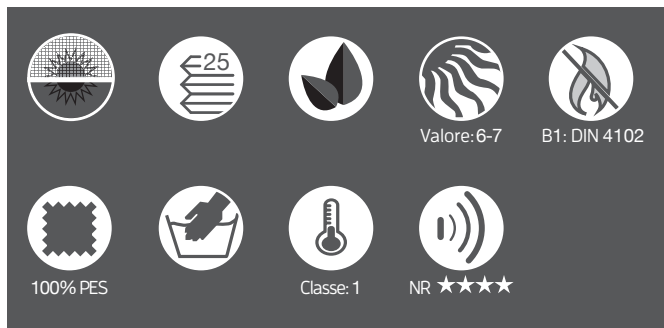

FIRE RETARDANT

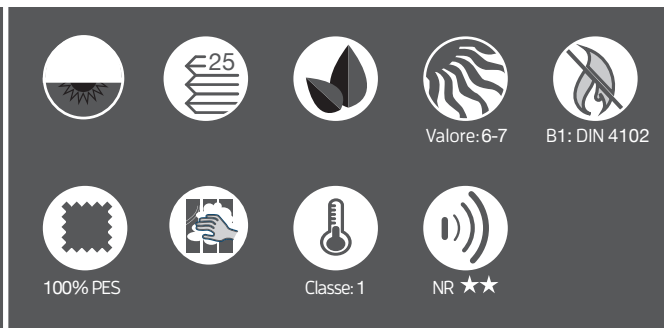

Gli oscuranti non garantiscono un oscuramento totale in quanto montati su sistema non a tenuta di luce.

8020I

*
g-tot
0.44



6020I

*
g-tot
0.33

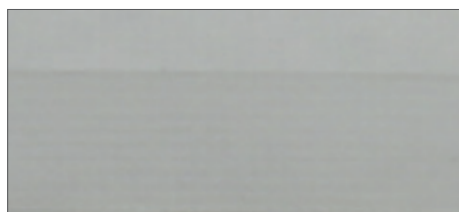

8016I

*
g-tot
0.44

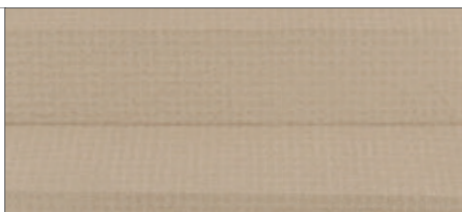

6016I

*
g-tot
0.33

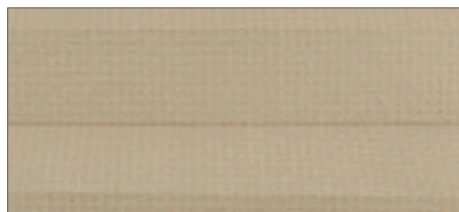

81238

*
g-tot
0.45



61238

*
g-tot
0.33

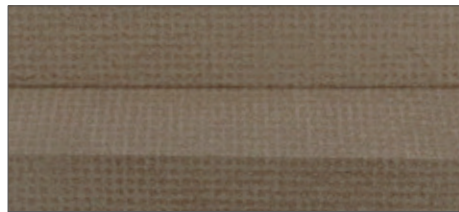

84935

*
g-tot
0.44

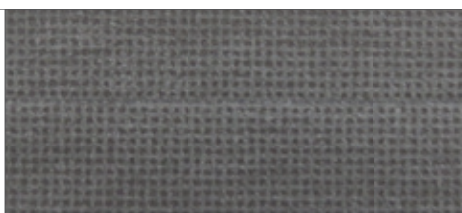

64935

*
g-tot
0.33



8713I

*
g-tot
0.47



67132

*
g-tot
0.33



LINEA INDOOR



LEGENDA E SIMBOLI



Filtrante



Solidità colore
ISO 105 B02



Manutenzione:
Lavabile a mano



Oscurante



Ignifugo



Classe di confort termico
UNI EN 14501:2006



Tessuti cellulari
per tende plissè



Composizione



Classe di isolamento
acustico



Esente da
PVC e alogeni



Manutenzione:
pulire con panno umido

* Fattore solare g-tot UNI EN 13363-1:2003 calcolato con vetratura tipo C come da normativa UNI EN 14501:2006

PERFECTA+NANOBLIND

RULLO



OSCURANTI

Listino Tariffa

A

	A001
	A055
	A025
	A026
	A007
	A033
	A081
	A019
	A018
	A056



FILTRANTI

Listino Tariffa

A

	T401
	T405
	T404
	T403
	T411
	T412
	T406
	T409
	T410
	T408



100% PES



Classe: 1
UNI 9177



Classe: 1



Fattore solare g-tot* UNI EN 13363-1:2003

A001	A007	A018	A019	A025
0.43	0.43	0.43	0.43	0.43
A026	A033	A055	A056	A081
0.43	0.43	0.43	0.43	0.43



100% PES



Classe: 1
UNI 9177



Classe: 1

Fattore solare g-tot* UNI EN 13363-1:2003

T401	T403	T404	T405	T406
0.37	0.38	0.44	0.52	0.36
T408	T409	T410	T411	T412
0.41	0.45	0.43	0.41	0.40

FILTRANTI

Listino Tariffa

B

024
025

100% PES



Classe: 1

Fattore solare g-tot* UNI EN 13363-1:2003

024	025
0.39	0.47

FILTRANTI

Listino Tariffa

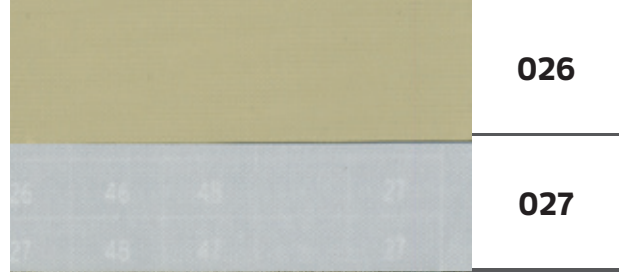
B

026
027

100% PES



B 1: DIN 4102



Classe: 1



Fattore solare g-tot* UNI EN 13363-1:2003

026	027
0.44	0.42

FILTRANTI

Listino Tariffa

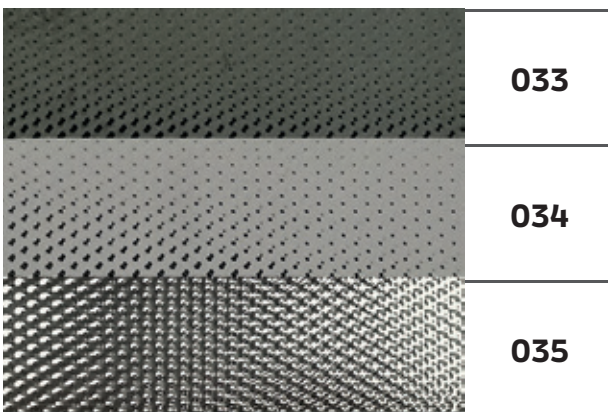
C

033
034
035

100% PES



Classe: 1

Fattore solare g-tot* UNI EN 13363-1:2003

033	034	035
0.52	0.33	0.38

LEGENDA E SIMBOLI

Oscurante



Filtrante Opaco



Filtrante



Filtrante Trasparente



Composizione



Ignifugo



Esente da PVC e alogeni



Manutenzione: pulire con panno umido

 Classe di confort termico
UNI EN 14501:2006

Gli oscuranti non garantiscono un oscuramento totale in quanto montati su sistema non a tenuta di luce.



* g-tot calcolato con vetratura tipo C come da normativa UNI EN 14501:2006



NANOBLIND

SINGLE - DOUBLE



LINEA INDOOR



COLORE ALLUMINIO

RAL standard

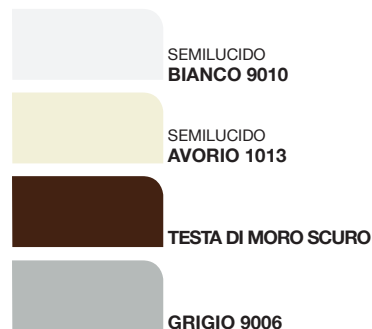

LEGNO +10%

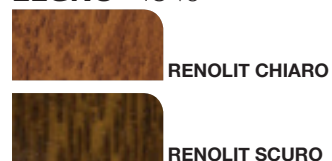

Ulteriori colorazioni a preventivo

COME RILEVARE LE MISURE

Si consiglia l'uso dello speciale metro "giudice", per il corretto rilievo delle misure.

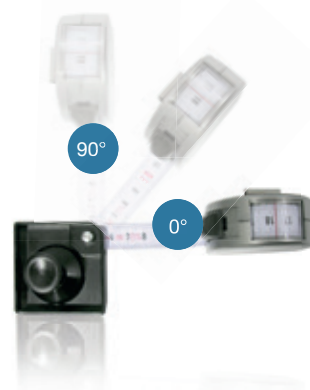

È una tenda tecnica da interno frizionata con meccanica a rullo.

L'ampia possibilità di teli oscuranti e filtranti ne permette l'applicazione in diversi ambienti, integrandola con l'infisso.

Disponibile di serie con cassonetto singolo per altezza max 1400 mm o doppio per altezza max 1800 mm (2300 mm per categoria B).

L'installazione è facile e immediata, si ottiene tramite l'applicazione adesiva della tenda sul vetro.

ATTENZIONE: I teli oscuranti non garantiscono un oscuramento totale del 100%.

COLORE ACCESSORI



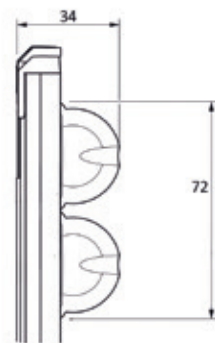
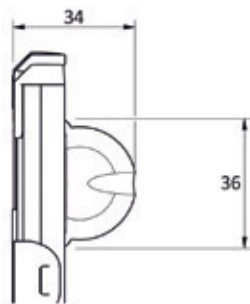

! MISURE CONSIGLIATE (cm)

SINGLE		L	H
MIN.		40	40
MAX.		120	140
DOUBLE		L	H
MIN.		40	70
MAX.		120	180*

(*) per installazione in posizione perfettamente verticale (0°). La realizzazione con teli della categoria B può essere effettuata per una altezza massima di 230 cm.

OPTIONAL

ASTA DI AZIONAMENTO H 75 cm

€ 26,00



LISTINO B IVA ESCLUSA

NANOBLIND - SINGLE

Largh.	40			50			60			70			80			90			100			110			120			
Altezza (cm)	40	78	80	94	85	88	106	93	97	117	101	104	129	110	114	143	118	124	155	126	131	158	134	139	177	140	147	190
	50	82	85	102	91	94	114	98	102	128	106	110	140	116	122	156	124	130	168	132	139	180	139	147	194	148	155	206
	60	88	90	110	95	99	124	103	108	138	111	116	151	123	129	168	130	137	181	139	145	196	146	155	209	155	164	224
	70	92	95	118	100	104	133	108	113	148	117	124	163	128	134	180	136	144	196	144	153	211	153	163	226	162	172	240
	80	96	100	126	105	109	142	113	119	159	123	129	174	134	141	193	142	150	209	150	161	226	160	170	242	169	180	258
	90	101	105	134	109	115	150	118	125	168	128	135	185	139	148	206	148	159	222	158	168	240	166	178	258	175	188	274
	100	105	110	141	114	121	160	124	131	178	134	141	197	144	155	217	155	165	237	164	175	254	173	185	273	182	197	291
	110	109	114	149	118	126	168	129	137	188	139	148	208	150	161	231	160	172	250	170	183	270	180	195	288	190	205	309
	120	113	119	158	124	131	178	134	143	199	144	155	219	157	168	242	166	179	264	176	191	284	186	202	305	196	213	325
	130	118	125	165	129	137	186	139	148	209	149	160	232	162	175	255	172	185	278	182	198	299	193	210	321	203	221	343
140	124	130	173	134	142	196	144	155	219	155	166	242	168	180	268	178	194	290	190	206	314	200	217	337	210	230	361	
Cat.	A	B	C	A	B	C	A	B	C	A	B	C	A	B	C	A	B	C	A	B	C	A	B	C	A	B	C	

NANOBLIND - DOUBLE

Largh.	40			50			60			70			80			90			100			110			120			
Altezza (cm)	40	103	106	123	113	117	138	125	129	152	135	139	168	150	155	187	161	166	203	171	177	217	181	188	233	192	199	247
	50	108	111	130	118	123	146	130	134	163	140	145	179	156	162	201	167	173	216	177	185	232	188	196	248	199	207	265
	60	113	116	139	124	129	156	135	139	173	145	151	191	162	169	212	173	180	230	184	192	247	195	204	265	206	216	282
	70	117	122	146	129	134	165	140	145	183	151	158	201	168	175	226	179	187	243	191	200	263	201	211	280	212	225	299
	80	123	126	155	134	139	174	145	151	194	157	165	213	174	181	237	185	195	258	197	207	277	208	219	297	220	232	316
	90	127	131	162	139	144	182	150	158	204	162	170	225	179	188	250	191	201	271	203	214	293	215	228	313	227	241	334
	100	131	136	170	143	149	192	156	163	214	168	176	236	185	196	264	197	209	284	209	221	307	221	236	329	234	249	350
	110	135	141	178	148	155	201	161	169	225	173	182	247	191	202	275	203	216	299	216	230	321	228	243	345	241	258	368
	120	140	146	185	153	160	210	166	175	234	178	190	259	196	208	288	209	222	312	221	237	336	235	251	361	247	266	385
	130	144	150	194	158	166	219	171	180	244	184	196	270	202	215	301	215	230	325	229	244	351	242	260	376	254	274	402
	140	149	156	201	163	171	228	176	186	254	190	201	281	208	221	313	221	237	340	235	252	366	248	268	392	262	282	419
	150	155	161	210	168	176	237	181	192	265	196	207	294	214	229	325	228	244	353	242	260	381	255	275	409	269	290	437
	160	159	166	217	172	182	247	186	198	276	201	214	304	219	235	338	234	251	367	247	268	397	262	283	424	276	299	453
	170	163	171	226	177	187	255	192	204	285	206	220	315	226	242	350	240	258	381	253	274	411	268	290	441	283	307	471
	180	167	176	233	182	193	265	197	210	296	211	227	327	232	248	364	246	265	394	261	282	425	275	299	457	289	315	488
	190	-	180	-	-	198	-	-	215	-	-	233	-	-	255	-	-	273	-	-	289	-	-	307	-	-	324	-
	200	-	185	-	-	204	-	-	221	-	-	239	-	-	262	-	-	279	-	-	297	-	-	314	-	-	333	-
	210	-	191	-	-	209	-	-	227	-	-	245	-	-	268	-	-	286	-	-	304	-	-	322	-	-	-	-
220	-	196	-	-	214	-	-	233	-	-	251	-	-	275	-	-	294	-	-	312	-	-	330	-	-	-	-	
230	-	201	-	-	220	-	-	239	-	-	258	-	-	282	-	-	301	-	-	319	-	-	339	-	-	-	-	
Cat.	A	B	C	A	B	C	A	B	C	A	B	C	A	B	C	A	B	C	A	B	C	A	B	C	A	B	C	

Prezzi validi per i colori **RAL** standard, +10% per i colori **LEGNO**.

